

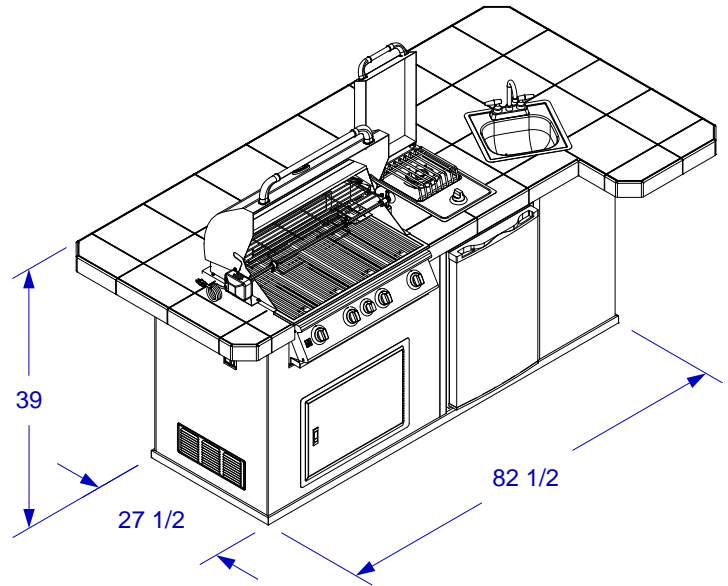

BBQ ISLAND SPEC SHEET

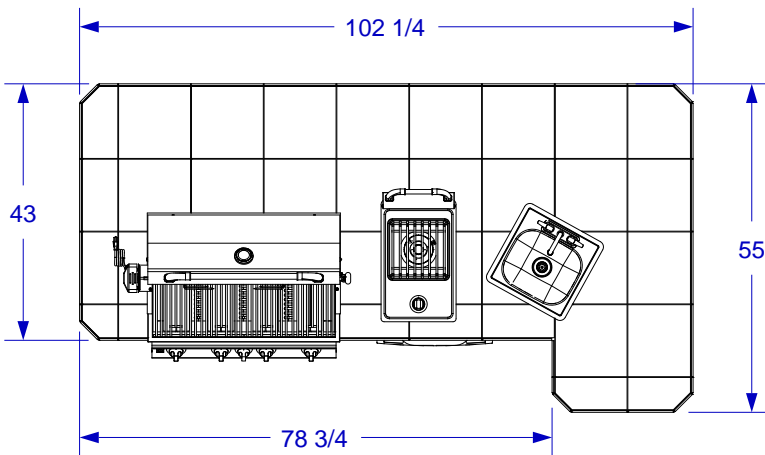

ISOMETRIC VIEW



TOP VIEW

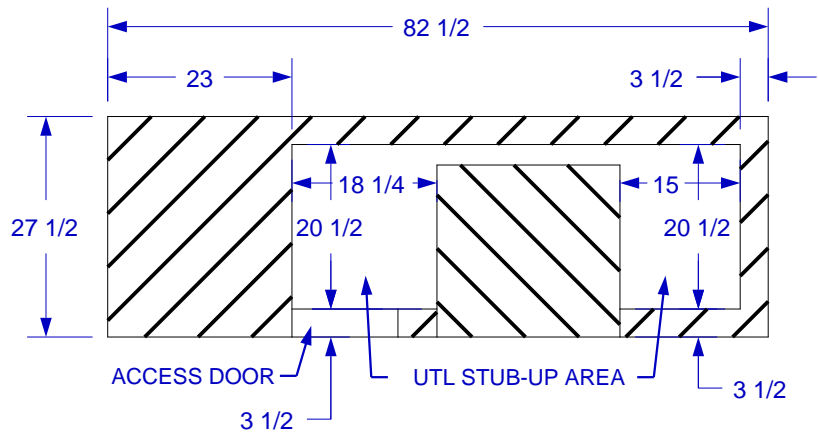

STUB-UP DIAGRAM
SCALE 1/2" = 1' 0"
(SEE NOTE #2)

- NOTES:**
1. FOR ROCK FINISHES, ADD 1 1/2" ON ALL BASE SIDES.
 2. 6" MAX HEIGHT ON ALL STUB-UPS.
 3. SHOWN WITH STANDARD 4-BURNER ANGUS GRILL
 4. SCALE: 3/8" = 1'-0"
 5. REVISION: 10/2011